

Tech Sheet: Siai Marchetti S.205/S.208

(siai-marchetti-S205.pdf)



Siai Marchetti S.205/208 Canopy, Engine & Prop Covers

Section 1: Canopy/Cockpit/Fuselage Covers

Canopy Covers help reduce damage to your airplane's upholstery and avionics caused by excessive heat, and they can eliminate problems caused by leaking door and window seals. They keep the windshield and window surfaces clean and help prevent vandalism and theft.

The **Siai Marchetti S.205/S.208 Canopy Cover** is designed to enclose the windshield, all side windows and canopy roof. The Canopy Cover is custom designed for each model, as well as your aircraft's specific antenna and temperature probe placements. The Canopy Cover attaches using adjustable "belly straps", which run under the belly and connect to the other side of the cover with a quick-release plastic buckle. To ensure the most secure fit, high-quality shock cord is enclosed in the hem of the cover to help keep the cover tighter against the airplane. Canopy Covers are commonly referred to as Cabin Covers, Fuselage Covers, Canvas Covers, Canopy Caps, etc.

Each Canopy Cover is custom sewn and the corners are trimmed to match the colors of the airplane. The airplane's registration number can be imprinted onto both sides of the cover for an additional charge. A duffle bag is included with all Canopy Covers.

This cover type is made from Silver Acrylic Sunbrella canvas and is 100% lined with a soft and smooth microfiber. Bruce's Custom Covers developed this material combination especially for aircraft protection. The outer material is medium weight and treated for water resistance, UV resistance and anti-static buildup. The inner lining is a very soft and smooth microfiber to prevent scratching. The material is very reflective, and tests show that the cabin interior temperature can be reduced to near-ambient temperature on the hottest of days. It is water, ice and snow repellent, yet breathable to allow moisture to escape from between the cover and the

aircraft surface.

The **Siai Marchetti S.205/S.208 Canopy/Engine Cover** is a one-piece cover (100% lined with microfiber) that is a combination of the Canopy Cover and Engine Cover. This cover will enclose the engine cowl and will extend aft to cover all of the windows. This cover type is made from Silver Acrylic Sunbrella canvas and is 100% lined with a soft and smooth microfiber. Bruce's Custom Covers developed this material combination especially for aircraft protection. The outer material is medium weight and treated for water resistance, UV resistance and anti-static buildup. The inner lining is a very soft and smooth microfiber to prevent scratching. The material is very reflective, and tests show that the cabin interior temperature can be reduced to near-ambient temperature on the hottest of days. It is water, ice and snow repellent, yet breathable to allow moisture to escape from between the cover and the aircraft surface.



Siai Marchetti S.205/208 Canopy, Engine & Prop Covers



Siai Marchetti S.205/208 Canopy Cover

Description	Part Number	Price
CANOPY COVER, BELLY STRAP TYPE	S205-000	\$590.00
CANOPY COVER, SNAP/BELLY STRAP TYPE	S205-005	\$590.00
CANOPY/ENGINE COVER	S205-010	\$965.00

Section 2: Engine/Prop Covers

Engine Covers will cinch around or behind the spinner, cover the entire engine cowl area including the engine air cooling and induction air inlets, and fastens together with Velcro beneath the spinner down the front of the cowling. The Engine Cover is attached with a belly strap aft of the firewall, and can Velcro to the Canopy Cover. Engine Covers are normally made from Solution-Dyed Polyester or Acrylic *Sunbrella*. An Insulated version of the engine cover can be made with a thicker, quilted, and water-repellent material. The Insulated Engine Cover works well in cold climates to help with engine preheating.

FOR INTERIOR USE - Protect your airplane's engine inside a cold winter hangar with our reasonably priced **Insulated Hangar Blanket**. While not as form fitting as our custom fit insulated engine covers, the **Hangar Blanket** will work wonders to help protect your engine when used with a heating device. AVAILABLE IN RED OR BLACK.

Insulated Covers Material - A special composite material of solution-dyed polyester, 3M Thinsulate insulation, and soft nylon interior fabric. Our insulated covers are designed to complement an engine preheater and help retain heat in the engine compartment after shutdown. If you operate your aircraft in cold-weather, these covers will help prevent engine wear and tear.

Sorry, custom flaps and preheater access is not available on the hangar blanketThe **Siai Marchetti S.205/S.208 Insulated Engine Cover** works well in cold climates to help with engine preheating. You can add an access flap for an additional fee. It will cinch around or behind the spinner, cover the entire engine cowl area including the engine air inlets, and fastens together with Velcro beneath the spinner down the front of the cowling.

Insulated Covers Material - A special composite material of solution-dyed polyester, 3M Thinsulate insulation, and soft nylon interior fabric. Our insulated covers are designed to complement an engine preheater and help retain heat in the engine compartment after shutdown. If you operate your aircraft in cold-weather, these covers will help prevent engine wear and tear.

The **Siai Marchetti S.205/S.208 Propeller Cover** is a one-piece design that form fits to the blades and spinner. The prop cover slips over the blades and spinner and is attached by a plastic all-weather zipper on the bottom of the blades. Propeller covers can be made for multiple numbers of blades, and for wooden, composite or metal props. The Propeller Cover is normally made from Acrylic *Sunbrella* or Solution-Dyed Polyester and is lined 100% with a soft and smooth microfiber. **Insulated Propeller Covers** works well in cold climates to help with engine preheating. These insulated versions are made with a thicker, quilted, water-repellent, and breathable material.

This cover type is made from Silver Acrylic Sunbrella canvas and is 100% lined with a soft and smooth microfiber. Bruce's Custom Covers developed this material combination especially for aircraft protection. The outer material is medium weight and treated for water resistance, UV resistance and anti-static buildup. The inner lining is a very soft and smooth microfiber to prevent scratching. The material is very reflective, and tests show that the cabin interior temperature can be reduced to near-ambient temperature on the hottest of days. It is water, ice and snow repellent, yet breathable to allow moisture to escape from between the cover and the aircraft surface.

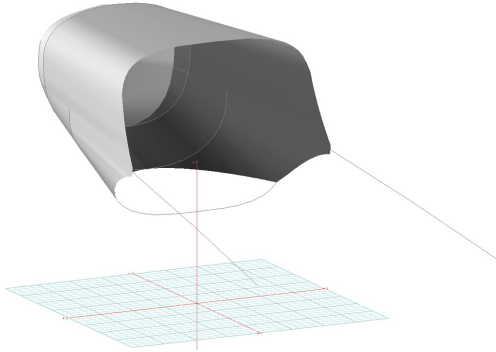

Siai Marchetti S205-18R Engine Cover, 3D Model

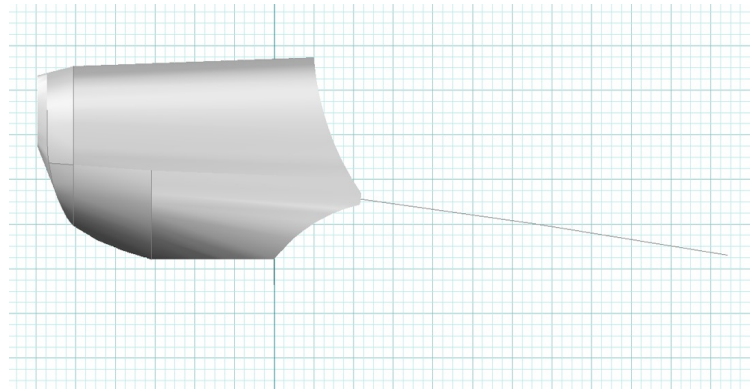

Siai Marchetti S205-18R Engine Cover, 3D Model

Description	Part Number	Price
ENGINE COVER	S205-110	\$470.00
INSULATED ENGINE COVER	S205-115	\$655.00
PROPELLOR/SPINNER COVER, 2 Blade	S205-120	\$300.00
INSULATED PROPELLOR/SPINNER COVER, 2 Blade	S205-125	\$450.00
PROPELLOR/SPINNER COVER, 3 Blade	S205-130	\$400.00
INSULATED PROPELLOR/SPINNER COVER, 3 Blade	S205-135	\$600.00
INSULATED HANGAR BLANKET, INTERIOR USE	S205-HB4	\$355.00

Section 3: Plugs & Protection

Engine Inlet Plugs are custom fit for your Siai Marchetti S.205/S.208 intakes, made with heavy-duty vinyl material, and stuffed with a single block of sculpted urethane foam. Each plug has a zipper that allows the foam to be removed and dried if necessary. Engine plugs have warning flags that are visible from the cockpit or 'remove before flight' streamers sewn onto the face of the plugs. Most plugs are imprinted with the aircraft registration number in black for an extra charge. Storage bag NOT included. Engine plugs may be inserted after flight when the engine is still warm. **Engine Inlet Plugs are commonly referred to as Cowl Plugs, Intake Plugs, Cowl Blocks, Engine Blocks, and Engine Bungs.**



ENGINE PLUGS PREVENT BIRD NEST FOD. Piper Saratoga Engine Cowling Bird's Nest

Description	Part Number	Price
ENGINE INLET PLUGS (set of 3)	S205-100	\$195.00

Section 7: Light Weight Products: Travel Covers and FlyAway Covers

The **Lightweight Travel Canopy Cover** will cover the same area as our standard Canopy Cover, but the material used is very lightweight and will fold up and store in a much smaller space. This cover is ideal for the airplane that is stored in a hangar full-time and only needs a cover on rare occasions.

Travel Covers are made with Silver Solution-Dyed Polyester fabric and only lined over the windshield to save weight. The material is lightweight and more compact for easy stowage in the aircraft. The polyester material is water resistant, but only intended for occasional use outside. We also have an ultra lightweight material available for fitted hangar dust covers. For daily outdoor use, the non-travel Sunbrella Cover is the best choice.



Siai Marchetti S.205/208 Canopy Cover

Description	Part Number	Price
TRAVEL COVER, Light Weight Canopy Cover	S205-800	\$475.00
TRAVEL COVER, Light Weight Canopy Cover, SNAP/BELLY STRAP TYPE	S205-810	\$475.00

Prices subject to change. Other Covers and Design Alterations: Prices on request.
Prices are FOB Morgan Hill, CA. Sales tax on orders shipped to California addresses. Orders take approximately 3 weeks to complete. For domestic orders we normally ship by UPS ground service. Next day shipping and air parcel post is available on request. We can take payment by Visa, Mastercard, American Express, or Discover.

Bruce's Custom Covers offers protective covers and plugs for virtually every type of airplane, jet and helicopter. If you have questions about our products please call any time TOLL FREE: 800/777-6405, or FAX: 408/738-2729.

Instructions: Measure to the nearest 1/8" and only fill in what applies. You may email, fax or phone in the measurements.

Aircraft Reg / Tail Number: _____ Aircraft Type: _____ Year: _____

Name: _____ Phone & Email: _____

OAT Placement

A	From top of windshield						
B	Offset from centerline						
	<table style="width: 100%; border-collapse: collapse;"> <tr> <td style="width: 33%; text-align: center;">Left</td> <td style="width: 33%; text-align: center;">Center</td> <td style="width: 33%; text-align: center;">Right</td> </tr> <tr> <td style="text-align: center;"><small>(pilot)</small></td> <td></td> <td style="text-align: center;"><small>(co-pilot)</small></td> </tr> </table>	Left	Center	Right	<small>(pilot)</small>		<small>(co-pilot)</small>
Left	Center	Right					
<small>(pilot)</small>		<small>(co-pilot)</small>					
C	Height						
D	From FWD edge						
E	From lower edge						
F	From forward corner						
G	Distance forward						



Antenna Placements	Example <small>(inches or metric)</small>	Antenna #1			Antenna #2			Antenna #3			Antenna #4			
H Distance from top center windshield to front of Antenna	34 5/8"													
J Length/Width of Antenna base	5 1/2" x 3 1/4"													
K Offset from Centerline	9 1/2"													
Antenna Offset (mark one)		Left <small>(pilot)</small>	Center X	Right <small>(co-pilot)</small>	Left <small>(pilot)</small>	Center <small>(co-pilot)</small>	Right <small>(co-pilot)</small>	Left <small>(pilot)</small>	Center <small>(co-pilot)</small>	Right <small>(co-pilot)</small>	Left <small>(pilot)</small>	Center <small>(co-pilot)</small>	Right <small>(co-pilot)</small>	
L Slope length of Antenna (types 1-3 only)	18"													
M Antenna Type (see types below)	1													



Instructions: Measure to the nearest 1/8" and only fill in what applies. You may email, fax or phone in the measurements.

Aircraft Reg / Tail Number: _____ Aircraft Type: _____ Year: _____
 Name: _____ Phone & Email: _____

Propellor Measurements

Please check one:	2 - Blade	3 - Blade	4 - Blade
A Measure along surface of cone			
B Measure "straight line" base to tip			
C Base to top of blade root opening			
D Provide diameter or circumference			
E Provide diameter or circumference			
F Blade root to prop tip			
G Trailing edge to leading edge			
H Trailing edge to leading edge			
J Trailing edge to leading edge			

